

EASY MOVE HOME LIFT

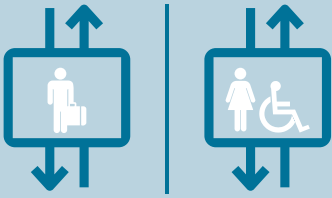

Tailor-made solutions for private and public premises

VIMEC
Easy moving



Easy Move

Easy Move meets the needs of two different types of user:

- **public and private facilities** in search of ways of overcoming architectural barriers through an installation that fits perfectly into its environment;
- **wheelchair users** who have chosen a vertical lift as the means of moving between floors in **their homes**.

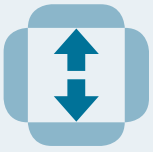

Versatile

The Easy Move lift gives added value to its setting, through simple tailor-made installations, both indoors and out.

Available **from two to five floors**, it is an ideal system both for renovation projects and for new buildings: no masonry work required.





Versatility,
comfort
and safety.

Quiet and discreet, it is absolutely convenient even for transporting the shopping, child buggies, and any other heavy or bulky items from one floor to another within the home. With the Easy Move, getting around the house could not be easier.

Easy Move fits into any surroundings, **guaranteeing your home a prestige installation that will increase its value.**

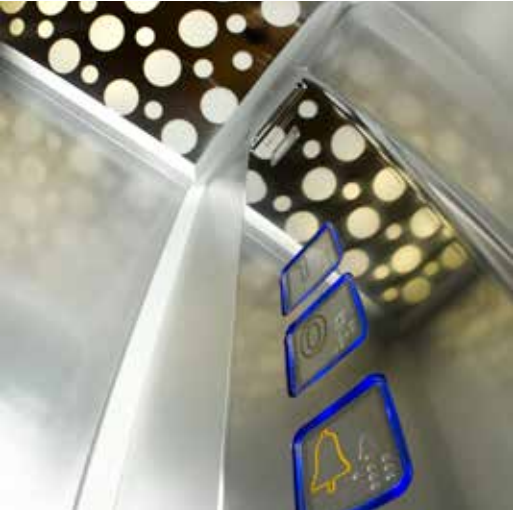

Plus

- Only occupies the space strictly necessary to ensure the user's comfort and safety
- Various personalisation options
- Suitable for both indoor and outdoor installation
- Quick to install with no major building work required
- Reliable, and with load capacity up to 400 kg
- On-board telephone and infrared barriers on three sides walls ensuring a safe ride



Design
and reliability

Vimec's focus on styling is expressed through the **shapes and materials chosen** to express wellbeing, attention to details, and a love of our work.



Customisable

The Easy Move lift is tailor-made not only in its functions but also in its personalised combinations; the colours and trims available enable the Easy Move to fit perfectly into any environment, whether a home or a public building.



Easy Move with structure

The Easy Move lift has state of the art structures in terms of strength, versatility and design.

These structures can be customised with different types of glass panelling to suit installations of all kinds, with tailor-made versions and installations even in particularly difficult applications.

A Vimec outdoor lift never requires invasive building works: installation is completed quickly and with great care, thanks to a network of skilled dealers always up to date with the latest products and techniques.





Accessories

Choosing your Easy Move's materials, colours and special comforts will be a thrill experienced every time you enter the cabin.

★ Doors



Automatic telescopic doors two speed



Three speed automatic telescopic doors



Double hinged, in glass, for an elegant, stylish effect



Panoramic, in aluminium; lightness at hand



Panoramic hollow veneered



Hollow veneered with vision panel

★ Control panels

On-board control panel

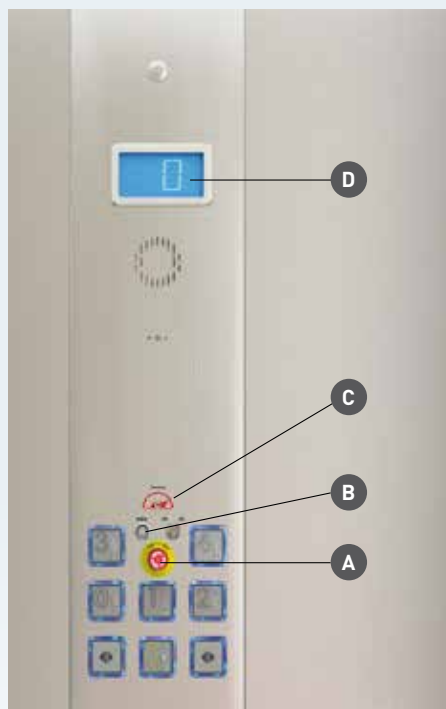

- A. Alarm pushbutton
- B. I-button, for electronic access floor controls
- C. Load indicator
- D. Display

Floor control panel

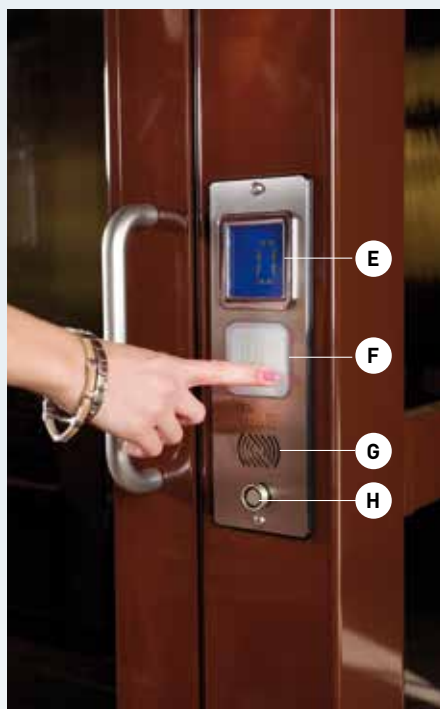

- E. LCD display with travel indicator
- F. Call button: green when lift is free, red when busy
- G. Loudspeaker
- H. I-button, for electronic access control

★ Structure

Personalized by the customer



★ Handrail

Integrated handle



★ Cabin lighting

LED bar standard



Starry sky





Colours and finishes

Easy Move offers you a hundred customisation options, starting from the walls of the cabin, available in different finishes and colours, through the platforms, in fine materials in a variety of shades. A wide choice of structure finishes are available to provide the best match with the surrounding colours and environment.

Cabin walls

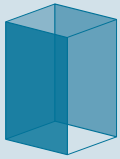

COLOR SERIES



Grey standard



Beige standard

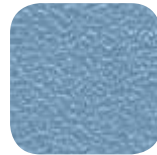

Blue standard



Red standard



Special RAL color

GLASS SERIES



Trasparent

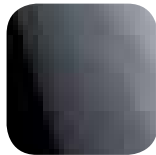

Smoked Grey

WOOD SERIES



Maple standard

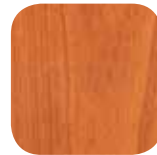

Cherry standard

INOX SERIES



Lino lucido

Cabin platform

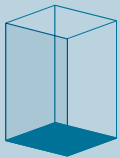

RUBBER SERIES



Grey with round stamps standard



Light Grey



Dark Grey



Red

WOOD SERIES



Pero selvaggio

SAFE STEP SERIES

Steel structure



STEEL STRUCTURE



VIMEC 7040 standard



RAL 1013 Pearl white



RAL 9023 Dark Grey pearl



Special RAL color



Features and technical specifications

- Versatile hydraulic lift
- Customisable to the needs of the user and the building
- Ideal both for renovation projects (easy to install in existing shafts) and in new installations, since special building works such as an extra room to house machinery, or a pit underneath the lift, are not required
- The pit required is truly negligible, since a recess just 12 cm deep is all that is needed
- The lift runs on the standard voltage of 220/240 V and its power consumption is 1.8 kW
- Certified to **Machinery Directive EC 2006/42**
- The installation is automatic when there are telescopic doors inside the cabin



Technical data

Working load	Up to 400 kg
Travel	9,5 m
Speed	0,15 m/sec.
Pit	120 mm for masonry shaft; 140 mm for structure
Cabin "enclosed" with walls or infrared barriers	
"Simple Touch" calling to floor	
Arrival and departure with soft start/stop system	
Device for communication with outside of cabin	
Automatic safety levelling within	+/- 20 mm
Certified safety valve	
Electric locks with En 81-2 certification	UNI EN 81-2
ELECTRICAL SYSTEM	
Power	1.8 kW
Mains voltage	230 V-single phase
Motor power supply voltage	230 V
Auxiliary power supply voltage	24 V
PLATFORM DIMENSIONS (4 standard configurations of platforms)	1250x1000
	1300x1030
	1400x1100
	1460x1170
Special platform sizes	Available on request

Data are guideline and not binding. Vimec reserves the right to make any changes it considers appropriate.



Dimensions and overall space requirements

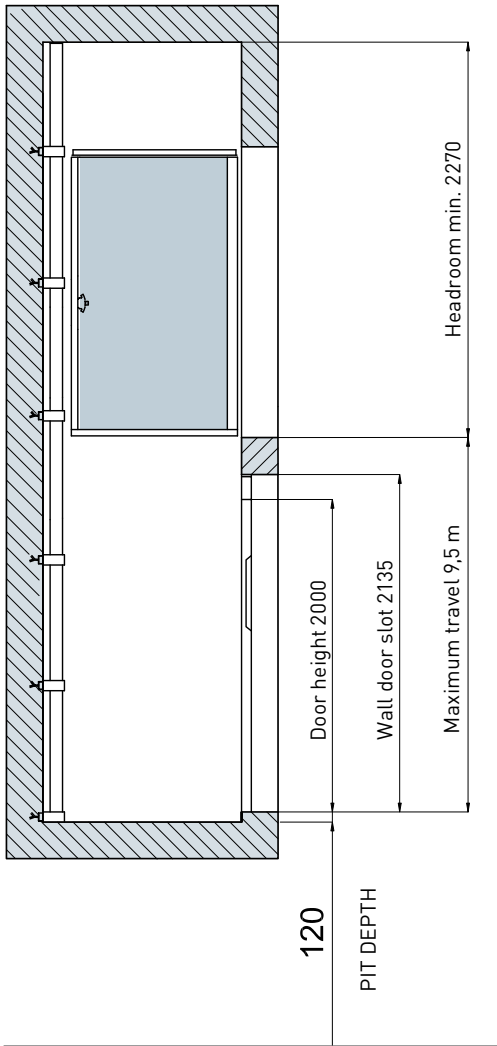

With telescopic doors

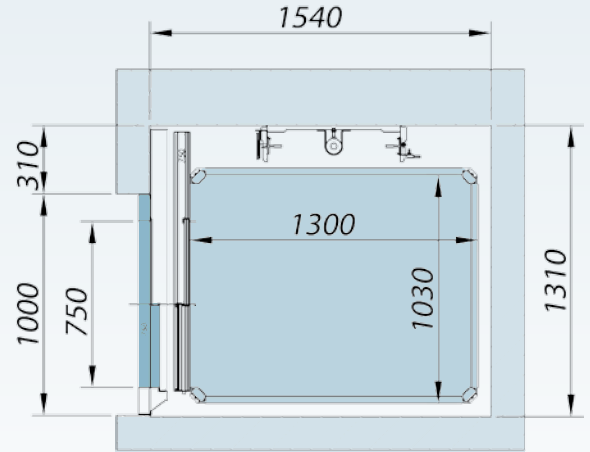

KEY

- L: Cabin width
- P: Cabin depth
- LH: Masonry shaft width
- PH: Masonry shaft depth
- LA: Free-standing structure width
- PA: Free-standing structure depth
- LN-PN: Door opening
- LE-PE: Door space occupancy

Masonry shaft

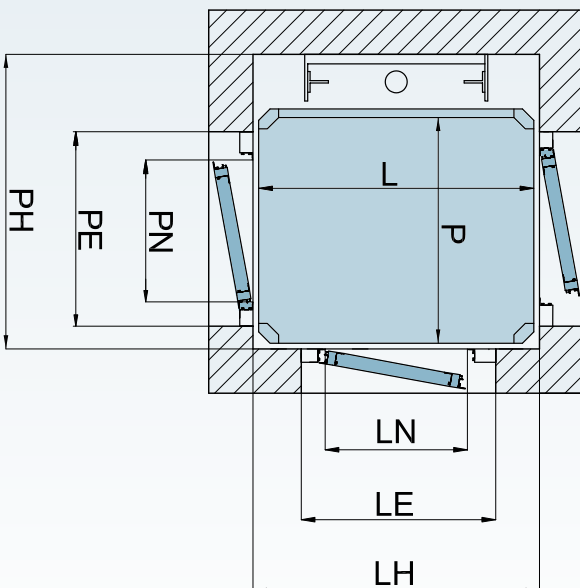

Structure

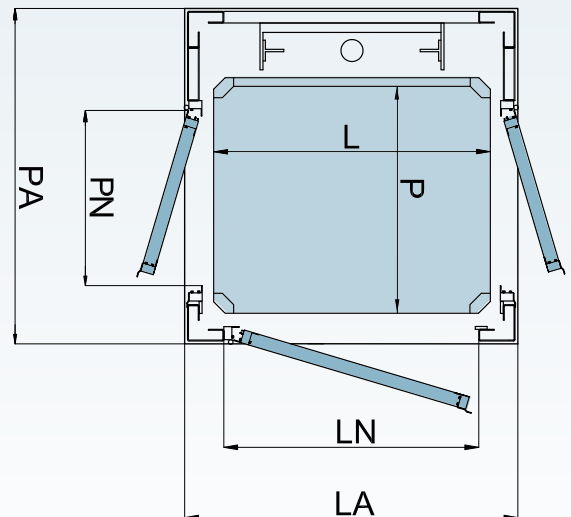

NB

Add 45 mm for each additional cabin wall, and 100 mm in case of folding door on board at cabin wall.

Masonry shaft

Cabin	L	900	1250	1400	770	850	1250
	P	850	1000	1100	950	1250	1250
Wall shaft	LH	930	1280	1430	800	880	1280
	PH	1090	1240	1340	1190	1490	1490

Structure

Cabin	L	900	1250	1400	850	1250
	P	850	1000	1100	1250	1250
Wall shaft	LA	1045	1395	1545	995	1395
	PA	1195	1345	1445	1595	1595



Heavy Duty: for higher load capacity

E07 HD

When the installation requires a lift able to take loads of considerable size and weight, the E07 Heavy Duty allows the transportation of trolleys, beds and other objects which require extra space, without difficulty and while maintaining a stylish appearance.



10 standard configurations
of platforms

1400x1300

1600x900

1800x900

2000x900

2200x900

1400x1400

1600x1000

1800x1000

2000x1000

2200x1100

Rated load

500 Kg to 600 Kg

Maximum travel

8,5 m

Data are guideline and not binding. Vimec reserves the right to make any changes it considers appropriate.

VIMEC Range

Since 1982 Vimec designs, manufactures and installs customized solutions: home lifts and elevators, chairlifts and stairlifts, platform lifts and mobile stair climbers.

**More than 100.000 installations
all over the world.**



Guaranteed product

Vimec chairlifts are guaranteed up to 24 months from consignment date.

Vimec Accessibility L.T.D.

Gadbrook House - Gadbrook Park
Northwich - Cheshire - CW9 7RG T
Tel. +44 01606 814 639
Head Office: Luzzara (RE) - Italy
export@vimec.biz
www.vimec.biz

Vimec subsidiaries:

Madrid (Spain)
Avignon (France)
Warsaw (Poland)

